

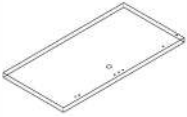





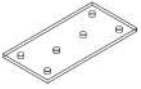
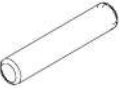

(1) Top  1PCS	(2) Modesty Panel  1PCS	(W) Grommet  2PCS	(S2) Flat bracket  4PCS	(A) Dowel  4PCS+1	(B) Cam Pin  3PCS+1	(C) Cam Lock  3PCS+1	(p) Cam Cover  3PCS+1	(E2) Wood screw  4PCS+2	(E4) Wood screw  24PCS+2	(D) Leg leveler  2PCS
--	---	--	--	---	--	--	--	---	--	---

STEP 1



STEP 2

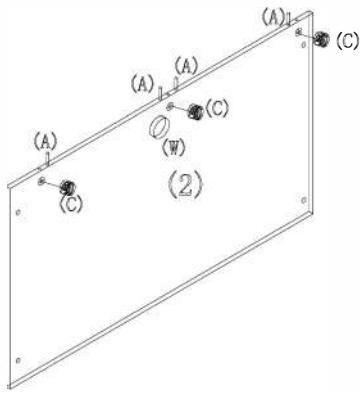
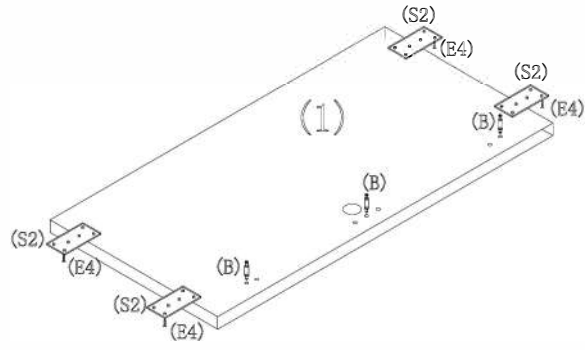

STEP 3

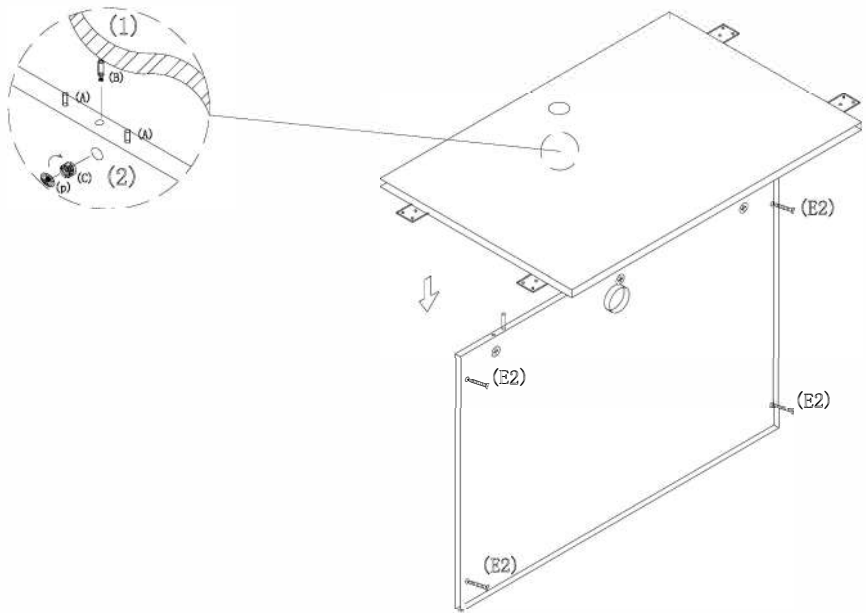

Bridge 35" x 24"
NAP-93
 35" W x 24" D x 29" H



Always lay components on A clean, soft-cushioned surface during assembly.